

Commander[®] **2000**

Security System Owner's Manual

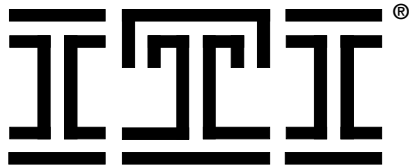

Interactive Technologies Inc.
2266 North 2nd Street
North St. Paul, MN 55109

FCC Notices

FCC Part 15 Information to the User

Changes or modifications not expressly approved by Interactive Technologies, Inc. can void the user's authority to operate the equipment.

FCC Part 15 Class B

This equipment has been tested and found to comply with the limits for a Class B digital device, pursuant to part 15 of the FCC Rules. These limits are designed to provide reasonable protection against harmful interference in a residential installation.

This equipment generates, uses and can radiate radio frequency energy and, if not installed and used in accordance with the instructions, may cause harmful interference to radio communications. However, there is no guarantee that interference will not occur in a particular installation.

If this equipment does cause harmful interference to radio or television reception, which can be determined by turning the equipment off and on, the user is encouraged to try to correct the interference by one or more of the following measures:

- Reorient or relocate the receiving antenna.
- Increase the separation between the equipment and receiver.
- Connect the affected equipment and the Panel receiver to separate outlets, on different branch circuits.
- Consult the dealer or an experienced radio/TV technician for help.

Commander and ITI are registered trademarks of Interactive Technologies, Inc.

Magic Key is a trademark of Interactive Technologies, Inc.

Energizer is a registered trademark of Eveready, Inc.

Ultralife is a registered trademark of Ultralife Batteries, Inc.

X-10 is a registered trademark of X-10 (USA) Inc.

For reprints order: 46-585-01-ITI Rev. D

Cover 46-702-ITI

Text: 46-701-ITI Rev. B

Copyright ITI 1998

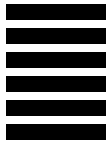

TABLE OF CONTENTS

SECTION 1—

| | |
|-------------------------------------|---|
| INTRODUCTION | 5 |
| How the System Works | 5 |
| Typical System Components | 5 |
| Panel | 8 |
| Wireless Sensors | 8 |
| Wireless Touchpads | 9 |
| Sirens | 9 |

SECTION 2—

| | |
|--|----|
| HOW THE SYSTEM COMMUNICATES TO YOU | 11 |
| Panel Indicator Lights | 11 |
| Alarm Sounds | 12 |
| System Status Beeps | 13 |
| Voice Messages | 14 |

SECTION 3—

| | |
|--|----|
| BASIC SYSTEM OPERATIONS | 15 |
| Using Access Codes | 15 |
| Primary Access Code | 15 |
| Temporary Access Code | 16 |
| Secondary Access Codes | 16 |
| Entering and Exiting Premises | 17 |
| Entering the Premises | 17 |
| Exiting the Premises | 17 |
| Arming and Disarming Your System | 18 |
| Turning System Off | 18 |
| Turning System On (STAY and AWAY) | 20 |
| Activating Emergency Alarms | 22 |
| Police, Fire, and Auxiliary/Medical Alarms | 23 |
| Silent Duress Alarm | 25 |

SECTION 4–

ADVANCED SYSTEM OPERATIONS27

Arming with No Alarm Delay (NO DELAY) 27

Bypassing Normally Armed Sensors (BYPASS) 28

Using the Chime Feature (CHIME) 29

Controlling Lights (LIGHTS) 30

 Panel Light Control 30

 User Light Control 30

Using and Programming the Magic Key 31

 Magic Key Voice Messages 32

Using the Keychain Touchpad 32

Checking the System Status (STATUS) 35

Checking for Alarms 36

Adjusting Panel Speaker Volume 37

SECTION 5–

MAINTAINING YOUR SYSTEM39

Required System Tests 39

Replacing Panel Backup Batteries 41

Replacing Smoke Sensor Batteries 44

Replacing Other Sensor Batteries 44

SECTION 6–

TROUBLESHOOTING YOUR SYSTEM45

SECTION 7–

PLANNING FOR EMERGENCIES49

Floor Plan 51

APPENDIX A–

ALARM SYSTEM NOTICE 53

GLOSSARY 55

INDEX 57

INTRODUCTION

Congratulations on your selection of the Commander 2000 security system! This system is designed to provide you with years of dependable service.

This manual includes step-by-step instructions for the proper use of your security system. Read this manual before you begin using your system.

How the System Works

The Commander 2000 security system is a wireless, supervised system. Wireless means that most sensors use radio waves instead of wires to communicate with the Control Panel (panel). With a supervised system, the wireless sensors communicate with the panel on a regular basis. There are three features that are unique to supervised security systems:

- **Automatic Sensor Communication Testing**

The system receives a signal from each sensor every 64 minutes. This signal tracks sensor communication.

- **User Friendly Arming**

The system tracks the status of each sensor and sounds protest beeps if sensors are open or have a trouble condition when you attempt to arm. If you ignore these protest beeps, the panel automatically bypasses the protesting sensor(s) and arms the system to the desired level.

- **Sensor Battery Monitoring**

The system notifies you of sensors with low batteries.

These three features help ensure that your Commander 2000 system handles alarm conditions in the appropriate manner.

Typical System Components

Figure 1 shows a typical system configuration, highlighting the devices that communicate with the panel and the devices that the panel controls in response to system conditions.

A description of typical system components begins on page 8.

THESE DEVICES REPORT TO THE PANEL.

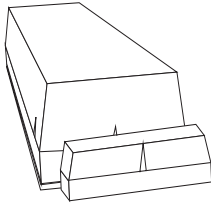

DOOR/WINDOW SENSOR
ITI PART NO. 60-686-43



4-BUTTON KEYCHAIN TOUCHPAD
ITI PART NO. 60-606

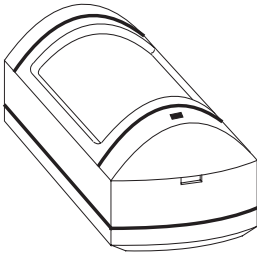

PIR MOTION DETECTOR
ITI PART NO. 60-639-43



HI-TECH HANDHELD TOUCHPAD
ITI PART NO. 60-687-43

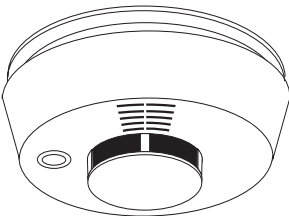

SMOKE SENSOR
ITI PART NO. 60-668-43

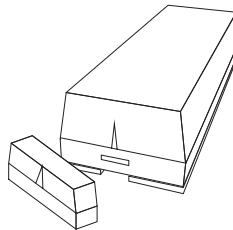

SHOCK SENSOR*
ITI PART NO. 60-706-43



*NOT INVESTIGATED BY UL.

Figure 1. Typical System Components

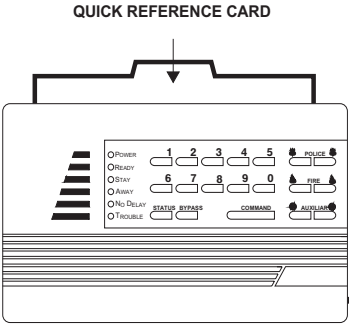

CONTROL PANEL
 ITI PART NO.
 60-676-43-8Z
 60-676-43-17Z

PROCESSES INFORMATION RECEIVED FROM SOME SENSORS AND CONTROLS OTHER SENSORS AND COMPONENTS IN RESPONSE TO INFORMATION RECEIVED. USER CONTROLS SYSTEM FROM HERE. INSTALLER PROGRAMS PANEL FROM HERE.

TELEPHONE LINE

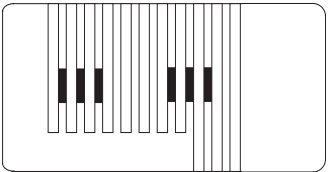
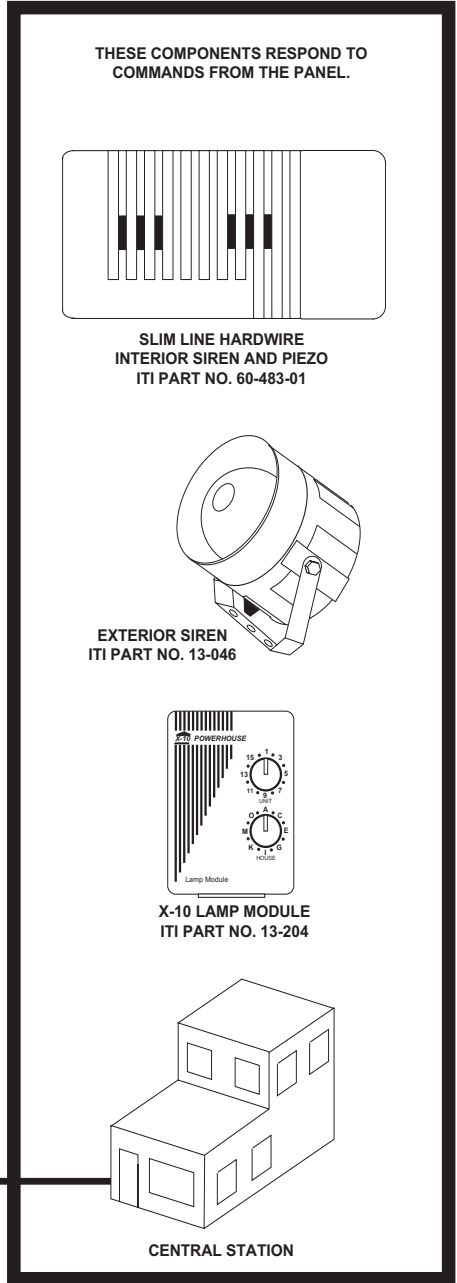

**SLIM LINE HARDWIRE
 INTERIOR SIREN AND PIEZO**
 ITI PART NO. 60-483-01

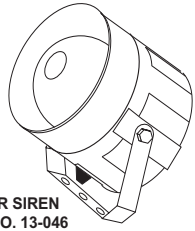

EXTERIOR SIREN
 ITI PART NO. 13-046

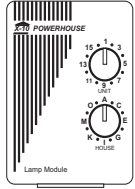

X-10 LAMP MODULE
 ITI PART NO. 13-204

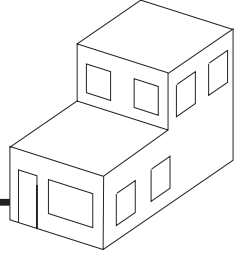

CENTRAL STATION

Panel

The panel is your security system's most vital component (see Figure 2). It performs four main functions:

- Lets you operate the system and set system options.
- Provides you with feedback from the system through indicator lights, voice messages, and status and alarm beeps.
- Receives signals from wireless sensors and wireless touchpads throughout the premises.
- Responds to alarm and trouble conditions by reporting with voice and alarm sounds; controlling output devices, including sirens and X-10[®] Lamp Modules; and if necessary, contacting your monitoring service over the phone line.

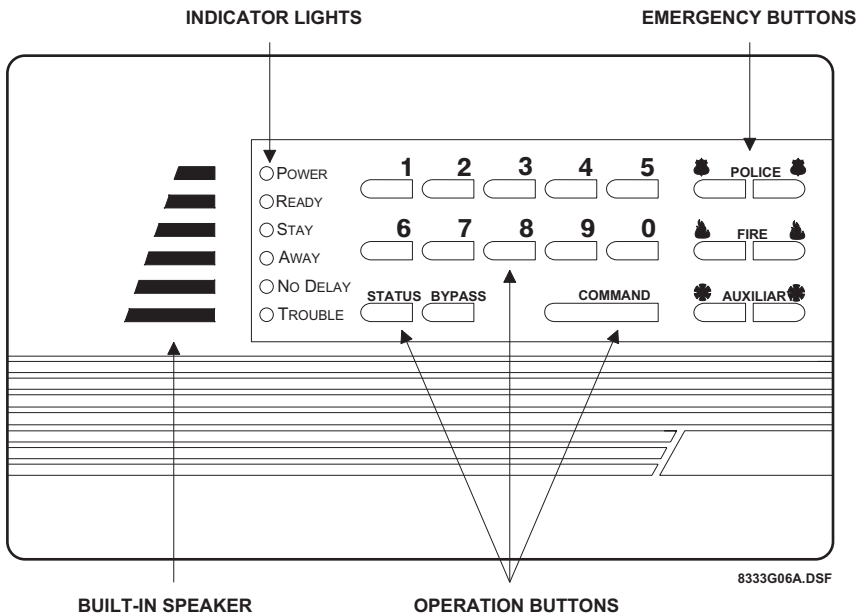

Figure 2. Panel Lights, Buttons, and Speaker

Wireless Sensors

Wireless sensors are your security system's detection devices. They perform two functions:

- Notifies the panel if a change in the normal state of a sensor occurs. For example, if the system is armed and you open a protected door, the sensor reports to the panel and an intrusion siren sounds.

- Checks in with the panel approximately every hour to indicate proper operation. If a sensor fails to report to the panel within a specified time (programmed by your security consultant), a communication failure is reported to the monitoring service and the system sounds trouble beeps (see Section 6, "Troubleshooting Your System").

Wireless Touchpads

Wireless touchpads let you operate the system inside or outside the premises. A wireless touchpad's range will vary, depending on the conditions of the premises and the location of the panel relative to the wireless touchpad.

NOTE: The Energy Saver option, shown on button 5 of the Handheld and Wall-Mount Wireless Touchpads, is not available with the Commander 2000.

Sirens

Sirens create two types of sounds, which alert you to the following:

- Alarm conditions
- System status

HOW THE SYSTEM COMMUNICATES TO YOU

This section describes how your security system uses indicator lights, alarm sounds, status beeps, and voice messages to communicate system information to you.

Panel Indicator Lights

The indicator lights on the panel provide system status information. Table 1 describes what each light means.

Table 1. Panel Indicator Lights

| Indicator Light † | ON ‡ | OFF | Blinking Δ |
|-------------------|--|---|---|
| POWER | AC power is on, and backup batteries are good. | AC power is OFF, and backup batteries are okay. | AC power is on, and backup batteries are bad. |
| READY | System is ready to arm. | Perimeter or interior sensors are open, not ready to arm. | Perimeter sensors are ready to arm, but interior sensors are open and system can only arm to level 2. |
| STAY | System is armed to level 2. | — | System is armed to level 2, with sensors bypassed. |
| AWAY | System is armed to level 3. | — | System is armed to level 3, with sensors bypassed. |
| NO DELAY | Delay is off. | Delay is on. | — |
| TROUBLE | — | System operating normally. | System is not operating properly. Press STATUS for a voice message of the problem. |

† All lights scrolling indicates either a phone test or sensor test is on, or an armed sensor is activated. Press **STATUS** for a description of the condition.

‡ All lights on steady indicates that the panel has lost its memory. Contact your security consultant immediately.

Δ All lights blinking indicates that the system is in program mode. Contact your security consultant immediately.

Alarm Sounds

Exterior and interior sirens make three alarm sounds on the premises (see Table 2). Fire alarms take precedence over auxiliary/medical alarms, which in turn take precedence over police alarms.

Table 2. Siren Alarm Sounds

| Siren Type | Description of Siren Sounds | |
|--------------------------|-----------------------------|---------|
| Fire Alarm | Steady tone | ————— |
| Police Alarm | Slow ON-OFF-ON-OFF | ——— ——— |
| Auxiliary/Medical Alarm* | Fast ON-OFF-ON-OFF | — — — — |

* Interior sirens only

System Status Beeps

The panel speaker and interior sirens provide system feedback by sounding status beeps. Table 3 describes the status beeps you may hear from your panel.

Table 3. Understanding Status Beeps

| Type | Pattern | Indicates |
|--------------|--|--|
| Arming Level | 1 beep | System disarmed to level 1. |
| | 2 beeps | System armed to level 2, or armed to level 2 and exit delay has expired. |
| | 3 beeps | System armed to level 3, or armed to level 3 and exit delay has expired. |
| Entry Delay | 2-beep continuous sequence * | System armed to level 2 and entry delay is in progress. |
| | 3-beep continuous sequence * | System armed to level 3 and entry delay is in progress. |
| Chime | 2-beep (1 long, 1 short) | System disarmed to level 1 with chime feature on while an exterior sensor opened. |
| Protest | 2-beep continuous sequence (1 long, 1 short) | <ol style="list-style-type: none"> 1. System disarmed after an alarm from a wireless touchpad, including Keychain Touchpad. 2. Attempt to arm to level 2 while the READY light is OFF, indicating an exterior sensor is open. 3. Attempt to arm to level 3 while the READY light is OFF (indicating an exterior sensor is open), or blinking (indicating an interior sensor is open). |
| Trouble | 6-beep sequence, once every minute | <ol style="list-style-type: none"> 1. System has AC power failure. 2. System has low sensor battery. 3. System has failure to communicate. 4. System has sensor failure. 5. System has low battery. 6. System's memory is clear. Press STATUS for a voice message of the problem (see Section 6, "Troubleshooting Your System"), or contact your security consultant. |

* Entry delay beeps sound at a more rapid pace if an alarm has occurred. Exit the premises immediately and call for emergency help from a neighbor's phone.

Voice Messages

The panel speaker announces voice messages of system and sensor information. These messages are described as they are encountered throughout this manual.

BASIC SYSTEM OPERATIONS

This section describes how to perform the basic system operations, including: using access codes, entering and exiting the premises, turning the system on and off, and activating emergency alarms.

Using Access Codes

An access code is a four-digit number that lets you operate the system and prevents unauthorized use of the system. An access code is required for most system commands (unless you are using the Magic Key™).

WARNING: Select access codes you and other system users will remember. If you forget your primary access code, contact your security consultant.

Primary Access Code

The primary access code allows you to perform all system commands. The system allows you to have one primary access code. The default primary access code is 1234. You should change your primary access code from the default to a number that you can remember.

■ To change your primary access code:

1. Enter primary **ACCESS CODE + STATUS + 8**.
The panel beeps once.
2. Enter the new primary **ACCESS CODE**.
After five seconds, the panel announces, *[new primary access code] OK*, indicating that the primary access code was changed.

NOTE: Because the first two digits of your duress code are the same as the first two digits of the primary access code, when you change the primary access code, the duress code also changes (see "Silent Duress Alarm" on page 25).

NOTE: If your temporary access code is disabled, then changing your primary access code will automatically make your *old primary access code* the new temporary access code. If you want the temporary access code to remain disabled, you must disable it again using your new primary

access code each time you change your primary access code.

Temporary Access Code

The temporary access code allows you to perform all system commands except changing access codes and bypassing sensors directly. The system allows you to have one temporary access code. You might give the temporary access code to a babysitter or other service personnel.

■ To add or change the temporary access code:

1. Enter primary **ACCESS CODE + STATUS + 7**.
The panel beeps once.
2. Enter the temporary **ACCESS CODE**.
After five seconds, the panel announces, *[temporary access code] OK*, indicating that the temporary access code was changed.

■ To disable the temporary access code:

1. Enter primary **ACCESS CODE + STATUS + 7**.
The panel beeps once.
2. Enter the primary **ACCESS CODE**.
After five seconds, the panel announces, *[primary access code] OK*, indicating that the temporary access code was deleted.

NOTE: If your temporary access code is disabled, then changing your primary access code will automatically make your old primary access code the new temporary access code. If you want the temporary access code to remain disabled, you must disable it again using your new primary access code each time you change your primary access code.

Secondary Access Codes

Secondary access codes allow you to perform all system commands, except changing access codes and bypassing sensors directly. You can have up to four secondary access codes. The secondary access codes can be used in the same way as the temporary access code, except the secondary access codes can only be set and changed by your security consultant.

Entering and Exiting Premises

While the system is armed, delay times let you enter or exit through designated delay doors without causing an alarm. A delay door is any door that is assigned a delay time. If you activate any sensor before you open the delay door, an instant alarm sounds. When entering the armed premises, you must disarm the system within the entry delay time. After arming the system, you must exit the premises before the exit delay time expires.

There are two types of delays: standard and extended. Your security consultant will set up and explain your system's delays. Contact your security consultant to have your delay times changed.

Entering the Premises

To prevent an alarm when entering the armed premises, you must:

- Enter the extended delay door and disarm the system within the extended delay time.

or– Enter the standard delay door and disarm the system within the standard entry delay time.

or– Enter the extended delay door, then enter the standard delay door and disarm the system within the standard entry delay time or within the time remaining for the extended delay, whichever is less.

Example: The extended delay is set to 4 minutes, and the standard entry delay is set to 32 seconds. If you enter the extended delay door and then open the standard delay door after 3 minutes and 50 seconds, you have 10 seconds to disarm the system.

If you enter the extended delay door and open the standard delay door after 2 minutes, the extended delay is canceled and you have 32 seconds to disarm the system.

Exiting the Premises

To prevent an alarm when exiting the armed premises, you must:

- Exit the standard delay door within the standard exit delay time.

or– Exit the extended delay door within the standard exit delay and the remaining extended delay.

Example: The standard exit delay is set to 32 seconds, and the extended delay is set to 4 minutes. If you arm your system and exit the standard delay door in 22 seconds, then you must exit the extended delay door within 4 minutes and 10 seconds.

Arming and Disarming Your System

This section describes levels of security and how to arm and disarm the system.

1

OFF

Turning System Off

Use level 1 (OFF) to turn the system off when entering the premises with the system armed to level 2 or 3 and when canceling an accidental alarm. Level 1 disarms your perimeter and interior sensors. The 24-hour sensors (such as smoke, heat, freeze, emergency buttons, and fire pull stations) always remain armed.

CAUTION: Do not enter the premises if you hear sirens. Call for emergency help from a neighbor's phone.

■ To disarm the system from the panel or a Handheld Touchpad:

1. Enter the premises through a delay door when the system is armed to level 2 or 3.

The panel and interior sirens sound entry delay beeps for the entire delay or until you disarm the panel. You must disarm the system before the delay time expires, or an alarm occurs.

CAUTION: Exit the premises immediately if the entry delay beeps sound at a more rapid pace. This indicates an alarm has occurred. Call for emergency help from a neighbor's phone.

2. Enter **ACCESS CODE + 1**.

The AWAY or STAY light turns off, and the panel and interior sirens sound an arming level beep, and the panel announces, *Alarm system is OFF*, if you disarmed from the panel.

CAUTION: If you disarm the system before entering the premises, do not enter the premises if you hear protest beeps. This indicates an alarm has occurred. Call for emergency help from a neighbor's phone. For more information on this feature, contact your security consultant.

3. Press **STATUS** to learn if there are any system problems.

■ To disarm the system from a Keychain Touchpad:

1. Enter the premises through a delay door when the system is armed to level 2 or 3.

The panel and interior sirens sound entry delay beeps for the entire delay or until you disarm the panel. You must disarm the system before the delay time expires or an alarm occurs.

CAUTION: Exit the premises immediately if the two- or three-beep sequence sounds at a more rapid pace. This indicates an alarm has occurred. Call for emergency help from a neighbor's phone.

2. Press the Disarm button on the Keychain Touchpad.

The AWAY or STAY light turns off, and the panel and interior sirens sound one short beep.

NOTE: Pressing the Disarm button will not disarm the system if an alarm was generated by simultaneously pressing the arm and disarm buttons.

CAUTION: If you disarm the system before entering the premises, do not enter the premises if you hear a two-beep continuous sequence (1 long, 1 short). This indicates an alarm has occurred. Call for emergency help from a neighbor's phone. For more information on this feature, contact your security consultant.

3. Press the **STATUS** button to learn if there are any system problems.

■ To disarm the system using a Magic Key:

1. Enter the premises through a delay door when the system is armed to level 2 or 3.

The panel and interior sirens sound entry delay beeps for the entire delay or until you disarm the panel. You must disarm the system before the delay time expires or an alarm occurs.

CAUTION: Exit the premises immediately if the entry delay beeps sound at a more rapid pace. This indicates an alarm has occurred. Call for emergency help from a neighbor's phone.

2. Insert the Magic Key into the panel key slot (see Figure 3).



Hold the Key steady in the slot until the panel and interior sirens sound an arming level beep and the panel announces, *Alarm system is OFF*. If any alarms occurred, the panel announces the sensors that were activated.

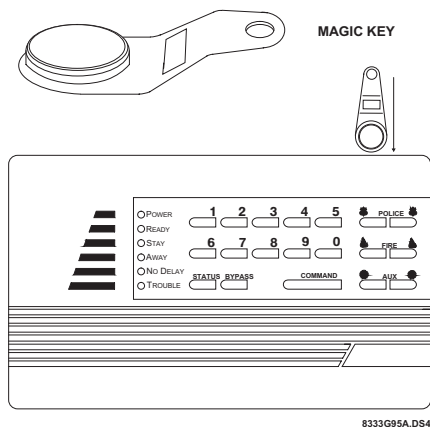

Figure 3. Inserting the Magic Key into the Slot

3. Press the **STATUS** button to find out if there are any system problems.

■ To turn off an accidental alarm:

1. With the panel in alarm, enter **ACCESS CODE + 1**.

The panel announces, *Sensor [sensor #] [alarm type] alarm memory. Alarm system is OFF*.

Example: *Sensor 16 intrusion alarm memory. Alarm system is OFF*. Alarm type may be intrusion, fire, or help.

If the panel is disarmed before a call is made to the monitoring service (from 8 to 20 seconds), the panel announces, *Sensor [sensor #] [alarm type] alarm memory. Alarm system is OFF. Alarm bypassed*.

Turning System On (STAY and AWAY)

Arming the system means you are turning on intrusion detection. Depending on the level you arm to, an alarm occurs if a perimeter or interior sensor is activated.

Use level 2 (STAY) when you want to stay in the premises with perimeter sensors armed. Using level 2, you can also leave the premises through any delay door during the delay time. Level 2 arms all perimeter sensors, including door/window, shock, and glass break sensors, as well as all sensors that are active in level 1 (24-hour sensors).

Use level 3 (AWAY) when you are leaving the premises and want all sensors armed. Level 3 arms all interior sensors, such as motion sensors, as well as all sensors that are active in levels 1 and 2.

2

STAY

3

AWAY

■ To arm the system from the panel or a Handheld Touchpad:

1. Close all perimeter doors and windows.
2. Check to see that the panel's READY light is on or blinking.

or– If the READY light is not on or blinking, press the **STATUS** button to learn if there are any system problems.

The system's voice message should provide you with the number of any sensors that are open. After double-checking those sensors, if the READY light is still not on or blinking, refer to "Bypassing Normally Armed Sensors (BYPASS)" on page 28. You also should contact your security consultant to resolve the problem.

3. From the panel or a touchpad, enter **ACCESS CODE + 2** or **ACCESS CODE + 3** to arm to level 2 or 3, respectively.

or– Enter **COMMAND + 2** or **COMMAND + 3**, if your system is set up for this capability.

Depending on which level you arm to, the panel's STAY or AWAY light turns on, the panel and interior sirens sound arming level beeps at the beginning of the exit delay, and the panel announces, *Alarm system is ON [level 2 or 3]*.

4. Exit the premises within the delay time, if you are leaving.
When the delay time expires, the panel and interior sirens sound arming level beeps again. If you are still in the premises and want to leave, disarm and rearm the system, or you may cause an accidental alarm.

■ To arm the system from a Keychain Touchpad:

1. Close all perimeter doors and windows.
2. Check to see that the panel's READY light is on or blinking.

or– If the READY light is not on or blinking, press the **STATUS** button at the panel or a touchpad to learn if there are any system problems.

The system's voice message should provide you with the number of any sensors that are open. After double-checking those sensors, if the READY light is still not on or blinking, refer to "Bypassing Normally Armed Sensors (BYPASS)" on page 28. You also should contact your security consultant to resolve the problem.

3. Press the Arm button until the light blinks.

The panel's STAY or AWAY light turns on, and the panel and interior sirens sound two or three beeps at the beginning of the exit delay.



NOTE: Depending on programming, a Keychain Touchpad may arm your system to the next higher arming level or directly to level 3 NO DELAY.

4. Exit the premises within the delay time, if you are leaving.
When the delay time expires, the panel and interior sirens sound two or three more beeps. If you are still on the premises and want to leave, disarm and rearm the system to prevent an accidental alarm.

■ To arm the system using a Magic Key:

1. Close all perimeter doors and windows.
2. Check to see that the panel's READY light is on or blinking.
If the READY light is still not on or blinking, check all perimeter doors and windows again to make sure they are closed. If the READY light is still not on or blinking, see "Bypassing Normally Armed Sensors (BYPASS)" on page 28.
3. Insert the Magic Key into the panel key slot (see Figure 3).

NOTE: The Magic Key rearms the system to its previous arming level (level 2 or 3). See "Using and Programming the Magic Key" on page 31 for more information.

4. Hold the Magic Key steady in the slot until the panel and interior sirens sound arming level beeps, and the panel announces, *Alarm system is ON [level 2 or 3]*.
5. Exit the premises within the delay time, if you are leaving.
When the delay time expires, the panel and interior sirens sound arming level beeps again. If you are still in the premises and want to leave, disarm and rearm the system to prevent an accidental alarm.

Activating Emergency Alarms

The emergency buttons on the panel or touchpads allow you to activate the appropriate emergency alarm. Table 4 is a comparison of the alarms that indicates how you can use the panel and touchpads to activate each alarm and how you can expect your security system to respond to them.

Table 4. A comparison of the alarm types

| Alarm type | <i>Where you can activate the alarm</i> | | | <i>What the alarm activates</i> | | |
|-----------------------|---|--------------------------|--------------------------|---------------------------------|-----------------|----------------------------|
| | From the panel | From a Handheld Touchpad | From a Keychain Touchpad | Interior sirens | Exterior sirens | Monitoring service action |
| POLICE | Yes | Yes | * | Yes | Yes | Police alarm |
| FIRE | Yes | No | * | Yes | Yes | Fire alarm |
| AUXILIARY/ MEDICAL | Yes | Yes | * | Yes | No | Pre-specified instructions |
| SILENT DURESS | Yes | No | * | No | No | Police alarm |

* Must be programmed by your security consultant

Police, Fire, and Auxiliary/Medical Alarms

Use the POLICE, FIRE, or AUXILIARY alarm buttons in an emergency.



A police alarm activates interior and exterior sirens and sends a police alarm to your monitoring service. The monitoring service should contact the police.



A fire alarm activates interior and exterior sirens and sends a fire alarm to your monitoring service. The monitoring service should contact the fire department.



An auxiliary/medical alarm activates interior sirens and sends an auxiliary/medical alarm to your monitoring service. The AUXILIARY button can be used to request either auxiliary or medical service, if the monitoring service knows in advance what service to contact in case of an alarm.

The emergency buttons are active in all security levels. The system recognizes the emergency buttons as sensors (see Table 5).

Table 5. Emergency Button Sensor Numbers

| Emergency Button | Sensor Number |
|------------------|---------------|
| POLICE | 81 |
| FIRE | 80 |
| AUXILIARY | 82 |

■ **To activate a police, fire, or auxiliary/medical alarm from the panel:**

Press and hold both emergency buttons at the same time, for at least 3 seconds.

or– Press both emergency buttons twice within 3 seconds.

or– Press **COMMAND**, then immediately press both emergency buttons at the same time.

The interior and exterior sirens and the panel sound the appropriate alarm. Exterior sirens do not sound for auxiliary/medical alarms.

■ **To activate a police or auxiliary/medical alarm from a Handheld Touchpad:**

Press and hold the appropriate emergency button for at least 3 seconds.

The interior and exterior sirens and the panel sound the appropriate alarm. Exterior sirens do not sound for auxiliary/medical alarms.

NOTE: The Handheld Touchpad only has a POLICE emergency button.

■ **To activate an alarm from a Keychain Touchpad:**

Simultaneously press the Arm and Disarm buttons until the light blinks to activate an alarm type set by your security consultant.

The interior and exterior sirens and the panel sound the appropriate alarm. Exterior sirens do not sound for auxiliary/medical alarms.

■ **To cancel a police, fire, or auxiliary/medical alarm:**

Enter **ACCESS CODE + 1** from the panel or a touchpad. Sirens are silenced, and the panel announces, *Sensor [sensor #] [alarm type] Alarm memory, Alarm system is OFF.* See Table 5 for the appropriate sensor number.



Silent Duress Alarm

If you are in a life-threatening situation (for example, if you enter the premises and find an intruder inside), you can enter the duress code instead of an access code while arming or disarming the system. The duress code causes the panel to send a silent duress alarm to the monitoring service. This notifies the monitoring service of a potentially life-threatening situation, but no alarms sound at the premises.

NOTE: If you do not have a monitoring service for your system, you cannot use the silent duress alarm feature.

The first two digits of your duress code are the same as the first two digits of your primary access code. The last two digits can only be changed by your security consultant or monitoring service.

■ To activate a silent duress alarm:

Enter **DURESS CODE + [1, 2, OR 3]**.

The panel and interior sirens sound the appropriate number of arming level beeps for the level you selected, and the panel announces, *Alarm system is [OFF or ON level #]*. The system immediately reports the duress alarm to the monitoring service.

NOTE: Silent duress alarms cannot be canceled.

ADVANCED SYSTEM OPERATIONS

This section describes how to perform the more advanced system operations, including: arming with no alarm delay, bypassing normally armed sensors, using the chime feature, controlling lights, and using and programming the Magic Key.

Arming with No Alarm Delay (NO DELAY)

4

NO DELAY

The No Delay feature is used when you want an alarm to sound immediately when a sensor is activated, if the system is armed to level 2 or 3 and if the sensor is normally delayed in that level. No Delay makes all normally delayed sensors instant for that arming period.

You might choose to use No Delay in a home when all family members are in for the night and you are ready to arm the system to level 2. If an intruder opens a delay door, an instant alarm occurs. You can also use No Delay if you are outside the premises, have a touchpad, and are leaving.

■ To arm the system with no alarm delay time:

1. Close all perimeter doors and windows.
2. Check to see that the READY light is on or blinking at the panel.
3. Enter **ACCESS CODE + [2 OR 3] + 4**.

or– Press **COMMAND + [2 OR 3] + 4**, if your system is set up for this capability.

The red STAY or AWAY light on the panel turns on, the panel and interior sirens sound arming level beeps, and the panel announces, *Alarm system is ON [level two or three]*. The NO DELAY light on the panel turns on, and the panel announces, *No delay*.

NOTE: Disarm the system before opening a perimeter door or window, or an accidental alarm may occur.

■ To arm the system with no alarm delay from a Keychain Touchpad:

1. Close all perimeter doors and windows.
2. Check to see that the READY light is on or blinking at the Panel.



3. Press the Arm button, then press the Star button and hold until the light blinks. The Panel's STAY or AWAY light turns on, and the Panel and interior sirens sound arming level beeps. The NO DELAY light turns on, and the Panel and interior sirens sound arming level beeps again.

NOTE: Disarm the system before opening a perimeter door or window, or an accidental alarm may occur.

NOTE: Depending on programming, a Keychain Touchpad may arm your system to the next higher arming level, or directly to level 3 NO DELAY.

Bypassing Normally Armed Sensors (BYPASS)

BYPASS

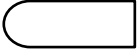

Use the Bypass feature to ignore selected sensors, so they can remain open or so they can be opened and closed without sending an alarm. Bypassing a window sensor allows you to leave the window open while the system is armed. Bypass also allows you to ignore a sensor that is not working properly and is causing unwanted alarms. You can bypass all sensors for any security level in which they are active, except smoke, heat, and fire pull sensors. Bypassed sensors remain bypassed until you change security levels.

You can bypass sensors indirectly or directly. Indirect bypassing lets you bypass open sensors when the system will not arm. Direct Bypass lets you bypass sensors when the system is armed and operating normally.

■ To bypass sensors indirectly:

1. Arm the system. If the panel announces, *Sensor [sensor #] open* and sounds protest beeps, continue to step 2.

If the panel arms successfully, you do not have to bypass any sensors.

2. Press **BYPASS**.

The panel announces, *Alarm system is ON [level #]. Sensor [sensor #] bypassed*.

NOTE: The indirect bypass procedure shall not be used in UL listed installations.

NOTE: The indirect bypass procedure does not work when you arm the panel by pressing the COMMAND button rather than entering your access code.

■ To bypass sensors indirectly from a Keychain Touchpad:

1. Press the Arm button. If the panel announces, *Sensor [sensor #] open* and sounds a two-beep continuous sequence (1 long, 1 short), continue to step 2.

If the panel arms successfully, you do not have to bypass any sensors.

2. Press the Arm button again.

Depending on which level you arm to, the panel's STAY or AWAY light turns on, the panel and interior sirens sound two or three beeps, and the panel announces, *Sensor [sensor #] bypassed*.

NOTE: The indirect bypass procedure cannot be used in UL listed installations.

■ To bypass sensors directly:

1. Enter primary **ACCESS CODE + [2 OR 3]** to arm the system to the desired level.
2. Enter primary **ACCESS CODE + BYPASS + [SENSOR #]**. Sensor numbers range from 01 to 18.

The panel announces, *Sensor [sensor #] bypassed*.

3. Repeat step 2 to bypass another sensor.

NOTE: You cannot bypass fire sensors, which include smoke, heat, and fire pull sensors. But you can bypass 24-hour police and auxiliary/medical sensors, including sensors in level 1 (see Table 5 for sensor numbers).

■ To remove all sensor bypasses:

Change the security level.

■ To remove a single sensor bypass:

1. Enter primary **ACCESS CODE + BYPASS + [SENSOR #]**.

The panel announces, *Sensor [sensor #] ON*.

If the panel announces, *Invalid, try again*, check that the sensor is closed, then repeat step 1.

2. Repeat step 1 to remove another sensor bypass.

Using the Chime Feature (CHIME)

7

CHIME

The Chime feature causes the system to sound chime beeps whenever a monitored perimeter door or window is opened. Chime only works in level 1, when the system is disarmed.

■ To turn Chime on or off:

1. Enter **ACCESS CODE + 1** from the panel or a touchpad to disarm the system.
2. Enter **ACCESS CODE + 7**.

or— Enter **COMMAND + 7**.

The panel announces, *ON* or *OFF*.

Controlling Lights (LIGHTS)

0

LIGHTS

X-10 Lamp Modules allow your system to turn lights on and off. X-10 Lamp Modules can control any incandescent lights that plug into an outlet.

Panel Light Control

The Panel instructs the X-10 Lamp Module to control lights as follows:

- During a fire alarm, lights turn on and remain on until the security level changes or after 12 hours with no system status change.
- During an intrusion alarm, lights blink until the siren time-out ends, then they remain on steady for up to 12 hours with no system status change.
- During entry and exit delay time, lights turn on and remain on for 5 minutes.

NOTE: If the system is disarmed during any of the above scenarios, lights controlled by X-10 Lamp Modules turn on steady and remain on for an additional 5 minutes.

User Light Control

Lights controlled by an X-10 Lamp Module can be turned on or off with the system in any security level.

■ To turn controlled lights on or off from the Panel or a Handheld Touchpad:

Enter **ACCESS CODE + 0**, with the Panel in any security level.

or– Enter **COMMAND + 0** from the Panel or a touchpad.

The Panel announces, *On* or *Off*.

■ To turn controlled lights on or off from a Keychain Touchpad:

Press and hold the Light button until the light blinks.

The Panel announces, *On* or *Off*. Controlled lights turn on or off, depending on the current setting.



Using and Programming the Magic Key

The Magic Key feature allows you to quickly change the arming level of your system from the panel without entering an access code and arming level. If you insert the Key into the panel's key slot while the system is armed to level 2 or 3, the panel disarms to level 1. If you insert the Key later, the panel rearms to level 2 or 3, respectively. Before you can use the Magic Key, you must first program the Key with a primary or temporary access code.

When you program a Magic Key with an access code, you can use the Key to disarm the system, and then rearm it to the previous arming level (level 2 or 3). A Key programmed for primary access works as long as your primary access code is not changed. A Key programmed for temporary access only works for a limited number of days (00-99). You can reprogram a temporary access Key at any time to increase or decrease the number of days, or change it to a primary access Key.

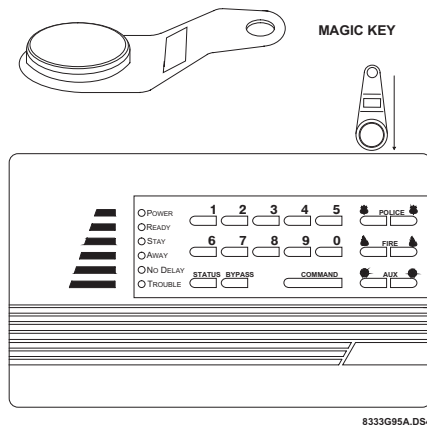

Figure 4. Inserting the Magic Key into the Slot

■ To program the Magic Key for primary access:

1. Enter primary **ACCESS CODE + STATUS + 8 + new primary ACCESS CODE**.
The panel announces, *[new primary access code] OK*.

NOTE: You can enter your current primary access code in place of a new primary access code if you do not want to change your code.

2. Insert the Key into the slot within 30 seconds of changing your primary access code (see Figure 4).
3. Hold the Key in the slot until the panel announces, *Memory OK*.

NOTE: You must reprogram the Magic Key whenever you change your primary access code.

■ To program Magic Key for temporary access:

1. Enter primary **ACCESS CODE + STATUS + 7 + new temporary ACCESS CODE**.
The panel announces, *[new temporary access code] OK*.

NOTE: You can enter your current temporary access code in place of a new temporary access code if you do not want to change your code.

2. Enter the number of days (00-99) you want the Key to work.
If you enter 00, the Key will work until midnight of the day the Key is programmed.
For numbers greater than 00, the Key will work until midnight of the assigned day.
3. Insert the Key into the slot within 30 seconds of changing your temporary access code (see Figure 4).
4. Hold the Key in the slot until the panel announces, *Memory OK*.

NOTE: You must reprogram the Magic Key if you change the temporary access code.

Magic Key Voice Messages

Table 6 describes voice messages you may hear when programming or using a Magic Key.

Table 6. Magic Key Voice Messages

| Message | Definition |
|----------------------------|---|
| <i>Memory OK</i> | Programming successfully completed. |
| <i>Invalid, try again.</i> | Key not recognized. Repeat procedure. |
| <i>Failure, good-bye.</i> | Key's programming prevents its use at this time. Reprogram Key or revalidate the temporary access code. |

Using the Keychain Touchpad

This section summarizes all the functions of the Keychain Touchpad. You can perform the following functions using the Keychain Touchpad:

- Arm the system
- Arm the system with no alarm delay time
- Disarm the system

- Activate an alarm
- Turn system-controlled lights on and off. (See also "Controlling Lights (LIGHTS)" on page 30.)
- Bypass sensors indirectly. (See also "Bypassing Normally Armed Sensors (BYPASS)" on page 28.)

■ To arm the system from a Keychain Touchpad:

1. Close all perimeter doors and windows.
2. Check to see that the panel's READY light is on or blinking.

or– If the READY light is not on or blinking, press the **STATUS** button at the panel or a touchpad to learn if there are any system problems.

The system's voice message should provide you with the number of any sensors that are open. After double-checking those sensors, if the READY light is still not on or blinking, refer to "Bypassing Normally Armed Sensors (BYPASS)" on page 28. You also should contact your security consultant to resolve the problem.



3. Press the Arm button until the light blinks.

The panel's STAY or AWAY light turns on, and the panel and interior sirens sound two or three beeps at the beginning of the exit delay.

NOTE: Depending on programming, a Keychain Touchpad may arm your system to the next higher arming level or directly to level 3 NO DELAY.

4. Exit the premises within the delay time, if you are leaving.

When the delay time expires, the panel and interior sirens sound two or three more beeps. If you are still on the premises and want to leave, disarm and rearm the system to prevent an accidental alarm.

■ To arm the system with no alarm delay from a Keychain Touchpad:

1. Close all perimeter doors and windows.
2. Check to see that the READY light is on or blinking at the Panel.
3. Press the Arm button, then press the Star button and hold until the light blinks.

The Panel's STAY or AWAY light turns on, and the Panel and interior sirens sound arming level beeps. The NO DELAY light turns on, and the Panel and interior sirens sound arming level beeps again.

NOTE: Disarm the system before opening a perimeter door or window, or an accidental alarm may occur.

NOTE: Depending on programming, a Keychain Touchpad may arm your system to the next higher arming level, or directly to level 3 NO DELAY.



■ To disarm the system from a Keychain Touchpad:

1. Enter the premises through a delay door when the system is armed to level 2 or 3.
The panel and interior sirens sound a two- or three-beep sequence, with a one-second pause between sequences. The beeping lasts for the entire delay or until you disarm the panel. You must disarm the system before the delay time expires or an alarm will occur.

CAUTION: Exit the premises immediately if the two- or three-beep sequence sounds at a more rapid pace. This indicates an alarm has occurred. Call for emergency help from a neighbor's phone.



2. Press the Disarm button on the Keychain Touchpad.
The AWAY or STAY light turns off, and the panel and interior sirens sound one short beep.

NOTE: Pressing the Disarm button will not disarm the system if an alarm was generated by simultaneously pressing the Arm and Disarm buttons.

CAUTION: If you disarm the system before entering the premises, do not enter the premises if you hear a two-beep continuous sequence (1 long, 1 short). This indicates an alarm has occurred. Call for emergency help from a neighbor's phone. For more information on this feature, contact your security consultant.

3. Press the **STATUS** button to learn if there are any system problems.

■ To bypass sensors indirectly from a Keychain Touchpad:



1. Press the Arm button. If the panel announces, *Sensor [sensor #] open* and sounds a two-beep continuous sequence (1 long, 1 short), continue to step 2.
If the panel arms successfully, you do not have to bypass any sensors.



2. Press the Arm button again.
Depending on which level you arm to, the panel's STAY or AWAY light turns on, the panel and interior sirens sound two or three beeps, and the panel announces, *Sensor [sensor #] bypassed*.

NOTE: The indirect bypass procedure cannot be used in UL listed installations.

■ To activate an alarm from a Keychain Touchpad:

Simultaneously press the Arm and Disarm buttons until the light blinks to activate an alarm type set by your security consultant.

The interior and exterior sirens and the panel sound the appropriate alarm. Exterior sirens do not sound for auxiliary/medical alarms.



■ To turn controlled lights on or off from a Keychain Touchpad:



Press the Light button and hold until the light blinks.

The Panel announces, *On* or *Off*. Controlled lights turn on or off, depending on the current setting.

Checking the System Status (STATUS)

STATUS



Whenever you disarm the system or experience system problems, check the system's status. The panel may notify you of the following conditions:

- Sensors that are open or have covers off
- Sensors with low batteries
- Sensors that are bypassed
- Condition of AC power
- Condition of backup batteries
- Sensor alarms that occurred during the arming period
- Sensors experiencing communication failure

■ To check system status:

Press **STATUS**.

The panel and interior sirens sound the appropriate number of arming level beeps for the current security level, and the panel announces the status of the system.

NOTE: If a sensor is open, the system announces the open sensor number instead of announcing the complete system status. The status of the system battery and AC power are announced only if there is a failure.

Table 7 shows a few system status messages that may be announced.

Table 7. Status Voice Messages and Their Meanings

| Voice Message | Meaning |
|---|--|
| <i>Alarm system is OFF, system battery is OK, AC power is OK.</i> | All sensors are closed, no system problems exist, and system is in level 1. |
| <i>Alarm system is OFF, sensor [sensor #] open.</i> | A perimeter sensor is open. Close or bypass sensor to arm system. |
| <i>Alarm system is OFF, sensor [sensor #] low battery.</i> | A sensor has a low battery. Contact your security consultant for sensor battery replacement. |
| <i>Alarm system is ON level 3, sensor [sensor #] bypassed.</i> | All sensors are armed except for the announced sensor. |
| <i>Alarm system is OFF, sensor [sensor #] trouble.</i> | Sensor cover is off. Put sensor cover on, then activate the sensor. For example, on a motion sensor, walk through its range of coverage. |
| <i>Invalid, try again.</i> | An incorrect or incomplete command was entered at the panel or from a touchpad. |
| <i>Alarm system is OFF, sensor [sensor #] failure.</i> | A sensor isn't working. Contact your security consultant. |

Checking for Alarms

The panel saves a record of any alarms that occurred while the system was armed. Use the following procedures to review any alarm messages stored in memory and clear the alarm memory when you no longer need the alarm messages.

■ To hear alarms in panel memory:

Enter **COMMAND + STATUS**.

The panel announces, *Sensor [sensor #] [alarm type] Alarm Memory*. If no alarms occurred during the arming period, the panel announces, *Alarm Memory is OK*.

■ To clear alarm memory:

1. Enter any **ACCESS CODE + 9**.

The panel and interior sirens sound one long beep and the panel announces, *Sensor test is ON*.

2. Enter any **ACCESS CODE + 1** to exit out of sensor test.

The panel announces, *Alarm system is OFF*. The alarm memory is now empty.

Adjusting Panel Speaker Volume

The panel has eight volume levels to choose from. Alarm sounds and alarm messages are always at full volume.

■ To adjust panel speaker volume:

Press **COMMAND** and hold until the desired volume is heard.

The panel announces, *Hello... hello... hello...* with a steadily decreasing volume, then returns to full volume and starts decreasing volume again.

MAINTAINING YOUR SYSTEM

Follow these maintenance procedures to help keep your system reliable and trouble-free.

Required System Tests

It is important that you check the system status and perform phone and sensor tests weekly. These procedures ensure that your system is fully operational.

■ To check system status:

With all sensors in their normally secure position, press **STATUS**.

The panel and interior sirens sound arming level beeps, corresponding to the current arming level. The panel announces system status, as shown in Table 8.

NOTE: If a sensor is open, the system announces only the open sensor number. The status of the backup battery and AC power are announced only if there is a problem.

Table 8. Voice Status Messages

| Main Message | Status | Level |
|------------------------|------------------|----------------|
| <i>Alarm System is</i> | <i>OFF</i> | — |
| | <i>ON</i> | <i>Level 2</i> |
| | <i>ON</i> | <i>Level 3</i> |
| <i>System Battery</i> | <i>is OK.</i> | — |
| | <i>Failure †</i> | — |
| <i>AC Power</i> | <i>is OK.</i> | — |
| | <i>Failure ‡</i> | — |

† See "Replacing Panel Backup Batteries" on page 41.

‡ Check if the AC power transformer is plugged in. Check the circuit breaker or fuse controlling the outlet. If you still don't have AC power, contact your security consultant.

■ To perform a phone test:

NOTE: Performing a phone test is only necessary if your security system is monitored by a monitoring service.

Enter **ACCESS CODE + 8**.

The panel and interior sirens sound one long beep, and the panel announces, *Phone test is ON*.

The system returns to level 1 when the phone test is complete. The panel announces, *Phone test is OK, Alarm system is OFF*.

If the panel announces, *Phone test failure, Alarm system is OFF*, make sure the panel is plugged into the phone jack. If a problem still exists, contact your security consultant immediately.

■ To perform a sensor test:

1. Enter **ACCESS CODE + 9**.

The panel and interior sirens sound one long beep, and the panel announces, *Sensor test is ON*. You have 15 minutes to complete the sensor test.

2. Activate each sensor, as described in Table 9.

The panel and interior sirens sound several beeps, and the panel announces, *Sensor [sensor #] OK*.

3. Press **STATUS** when you think all sensors have been tested.

The panel announces, *All sensors test OK*. If all sensors have not been tested, the panel announces a list of all untested sensors. Test all untested sensors.

4. If you need more time to complete the sensor test, enter **ACCESS CODE + 9**.

This gives you 15 minutes to complete the sensor test, and you don't have to retest any sensors.

5. Enter **ACCESS CODE + 1** to exit the sensor test at any time.

or— The panel goes to level 1 after 15 minutes in sensor test, if you do not exit first.

The panel announces, *Alarm system is OFF*.

NOTE: Performing a sensor test also clears the panel's alarm history (see "Checking for Alarms" on page 36).

Table 9. How to Activate Sensors During Sensor Test

| Sensor ‡ | Action |
|--|--|
| Door/Window | Open the secured door or window, and reclose it after it beeps. |
| Freeze | Apply ice or freeze spray to the sensor for about 45 seconds. Do not let the sensor get wet. |
| Glass Guard | † |
| Motion Sensor | Avoid sensor's view for 5 minutes, then enter its view. |
| Emergency Buttons on Touchpads and Panel | Press and hold the appropriate emergency button(s) for at least 3 seconds. Test all three emergency buttons (POLICE, FIRE, AUXILIARY). |
| Rate-of-Rise | Rub your hands together until warm, then place one hand on the sensor for 30 seconds. |
| Shock | † |
| Smoke | Press and hold the test button until the system sounds transmission beeps. |
| Water-Resistant Pendant Panic Sensor | Press the button on the sensor. |

† You cannot test this sensor. Your security consultant should test the sensor periodically.

‡ Your security consultant can explain how to test any additional sensors used with your system.

Replacing Panel Backup Batteries

Your panel uses six NiCd or alkaline backup batteries in case of an AC power failure. The actual length of time the panel will operate on backup batteries depends on your backup power time setting, the type of batteries used, and the condition of the batteries. The default setting for backup power is 5 hours and may be changed by your security consultant.

Test your backup batteries weekly by checking the system status, as described in the section "Required System Tests" on page 39. If the panel announces, *System battery failure* when you check system status, replace your batteries.

CAUTION: The panel may be damaged if the wrong batteries are installed. Make sure the batteries are all the same type and part number.

NOTE: Use only the following batteries:
Alkaline: Eveready E91, Duracell MN1500, Panasonic AM3X
NiCd: Panasonic P-70 AAS or P-60AA, Sanyo N-600-AA

■ To replace the panel's backup batteries:

1. Enter **ACCESS CODE + 1** to disarm the system to level 1. An alarm will occur if you do not disarm the system.
2. Loosen the two screws on the bottom of the panel until you are able to slide the door down and out (see Figure 5). Two full turns should be enough to allow you to remove the battery door without removing the screws completely.

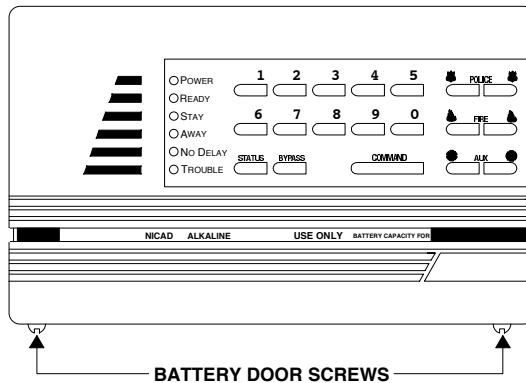

Figure 5. Loosen the two battery door screws

3. Check the battery type installed (NiCd or alkaline). You must use the same battery type that is currently installed (see Figure 6).

CAUTION: To avoid the risk of personal injury, equipment damage, and battery failure, only install the battery type that the tab indicates.

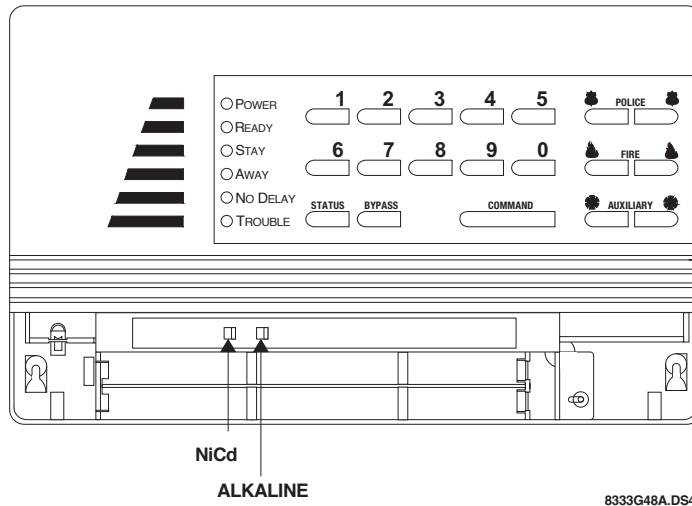

Figure 6. Tab Indicates Battery Type Installed

4. Remove the batteries from the battery bucket.
5. Insert appropriate new batteries in the order and direction shown in Figure 7.

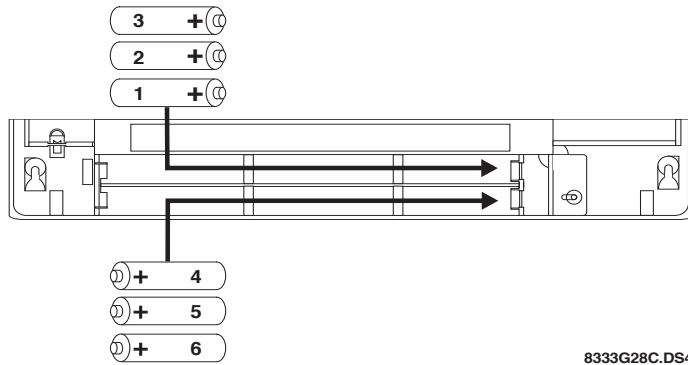

Figure 7. Battery Polarity and Order of Installation

6. Replace the battery door on the panel.
7. Wait 30 seconds, then press **STATUS**.

The panel should announce, *Alarm system is OFF, system battery is OK, AC power is OK*. If the panel announces, *Alarm system is OFF, system battery failure*, check the

battery installation. If the batteries are installed correctly, contact your security consultant.

NOTE: If NiCd batteries are not fully charged, it may take up to 24 hours for the system to fully recharge the batteries and clear the low battery warning. During this time, the system is fully operational unless an AC power failure occurs.

Replacing Smoke Sensor Batteries

The Smoke Sensor has two 9-volt batteries. Use only Eveready Alkaline Energizer[®] 522, Duracell MN 1604, or Ultralife[®] U 9VL Lithium 9-volt batteries. Replace the batteries in Smoke Sensors once a year.

■ To replace the batteries in a Smoke Sensor:

1. Remove the sensor from its base by turning the sensor counterclockwise until the line on the sensor aligns with the line on the base. Then, pull the sensor off the base.
2. Pull the batteries out of their compartments, and disconnect the batteries from the battery clips.
3. Connect the new batteries to the battery clips, and push the batteries into their compartments.
4. To attach the sensor to the base, put the sensor on the base, then align the line on the sensor with the line on the base. Turn the sensor clockwise until the sensor locks on the base (about $\frac{1}{4}$ turn).
5. Perform a sensor test on the Smoke Sensor to verify that the batteries are okay. See "Required System Tests" on page 39 to perform a sensor test.

Replacing Other Sensor Batteries

Although you can replace the batteries in the panel and in the Smoke Sensor, you must contact your security consultant to replace the batteries in all other sensors and touchpads. These devices use lithium batteries not available in retail stores.

TROUBLESHOOTING YOUR SYSTEM

Table 10 provides basic troubleshooting information.

Table 10. Troubleshooting Your System

| Problem | Solution |
|--|--|
| <p>Access Code</p> <p>Cannot remember access code.</p> | Contact your security consultant. |
| <p>Arming/Disarming</p> <p>System won't arm.</p> | <ul style="list-style-type: none"> • If arming to level 2, make sure all monitored perimeter doors and windows are closed. • If arming to level 3, make sure all perimeter and interior sensors are closed. • Press STATUS for a voice message of the problem. • If system still won't arm, contact your security consultant. |
| <p>Batteries</p> <p>Panel announces, <i>System battery failure</i>.</p> <p>Panel announces, <i>Sensor [sensor #] low battery</i>.</p> | <p>Replace panel backup batteries as described in "Replacing Panel Backup Batteries" on page 41.</p> <p>See "Replacing Smoke Sensor Batteries" on page 44 for the procedure to replace your own smoke sensor batteries, or contact your security consultant to have your other sensor batteries replaced.</p> |
| <p>Bypass</p> <p>Panel announces, <i>Invalid, try again</i> when you attempt to bypass a sensor.</p> <p>System cancels sensor bypass when you try to arm to level 2 or 3.</p> | <p>You are trying to bypass a 24-hour sensor that cannot be bypassed or a sensor that is not active in the current security level. You don't need to bypass this sensor.</p> <p>Arm to the desired level before you try bypassing a sensor.</p> |
| <p>False Alarm</p> <p>Alarm is being sent.</p> | Enter ACCESS CODE + 1 to cancel the alarm. This command bypasses the alarm if done within 8 to 20 seconds. |

Table 10. Troubleshooting Your System

| Problem | Solution |
|--|---|
| <p>Magic Key</p> <p>Temporary Access Magic Key does not disarm system.</p> | <p>Use has expired. Reprogram Magic Key.</p> |
| <p>Lights</p> <p>Light using X-10 Lamp Module doesn't work.</p> | <p>Check light bulbs. Check that light switch on lamp is turned ON. Make sure lamp is plugged into an X-10 Lamp Module. Make sure the lamp is plugged into a nonswitched outlet. If light control still doesn't work, contact your security consultant.</p> |
| <p>Panel</p> <p>All panel lights blink. Trouble beeps sound.</p> <p>All panel lights are on steady. Trouble beeps sound.</p> | <p>The system is in programming mode. Contact your security consultant.</p> <p>The system's memory is clear. Contact your security consultant.</p> |
| <p>Power</p> <p>Panel announces, <i>AC Power Failure</i>.</p> | <p>Check to see if AC transformer is plugged into an outlet. If it is, check circuit breaker or fuse that controls that outlet. If there is still an AC power failure, contact your security consultant.</p> |
| <p>Sensor</p> <p>Panel announces, <i>Sensor [sensor #] Trouble</i>.</p> <p>Panel announces, <i>Sensor [sensor #] Failure</i>.</p> <p>Panel announces, <i>Sensor [sensor #] low battery</i>.</p> | <p>Put the sensor's cover on, if it is off. Activate the sensor.</p> <p>The sensor is not communicating with the panel. Contact your security consultant.</p> <p>See "Replacing Smoke Sensor Batteries" on page 44 for the procedure to replace your own smoke sensor batteries, or contact your security consultant to have other sensor batteries replaced.</p> |

Table 10. Troubleshooting Your System

| Problem | Solution |
|--|---|
| <p>Smoke Sensor</p> <p>Beeps once every minute.</p> | <p>Batteries are low. Replace the smoke sensor batteries.</p> |
| <p>Telephone</p> <p>Telephone doesn't work.</p> | <p>Disconnect panel from phone jack. If the telephone works, contact your security consultant. If telephone still doesn't work, the system is OK; contact your telephone company.</p> |
| <p>Trouble Beeps (see also <i>Panel</i>)</p> <p>Six beeps occur every minute.</p> | <p>Press STATUS for a voice message of the problem. This disables the trouble beeps until the panel calls in its daily report. Contact your security consultant.</p> |
| <p>Wireless Interior Siren (WIS)</p> <p>Beeps once every minute</p> | <p>Battery is low. Replace the WIS battery.</p> |

PLANNING FOR EMERGENCIES

To protect yourself and others on the premises, create a map of the premises. Develop a plan for various emergencies, and practice your emergency plans. Figure 8 is an example of a floor plan. Draw a floor plan of your premises in Figure 9. Include the location of all system components. Be sure to show exits from each room (two exits per room are recommended).

Periodically discuss emergency procedures that include the following points:

- **Understanding how to use the security system.**
- **Knowing the normal state of the doors and windows of the premises, either open, closed or locked.**
- **Using alternate escape routes if closed doors feel hot to the touch.**
- **Crawling and holding breath.**
- **Escaping fast! (Do not stop to pack.)**
- **Meeting at a designated outdoor location.**
- **Conducting periodic rehearsals.**
- **Emphasizing that no one should return to the premises if there is a fire.**
- **Emphasizing that no one should enter the premises if they hear siren sounds.**

CAUTION: If you arrive at the premises and hear sirens, **DO NOT ENTER** the premises. Call for emergency assistance from a neighbor's phone.

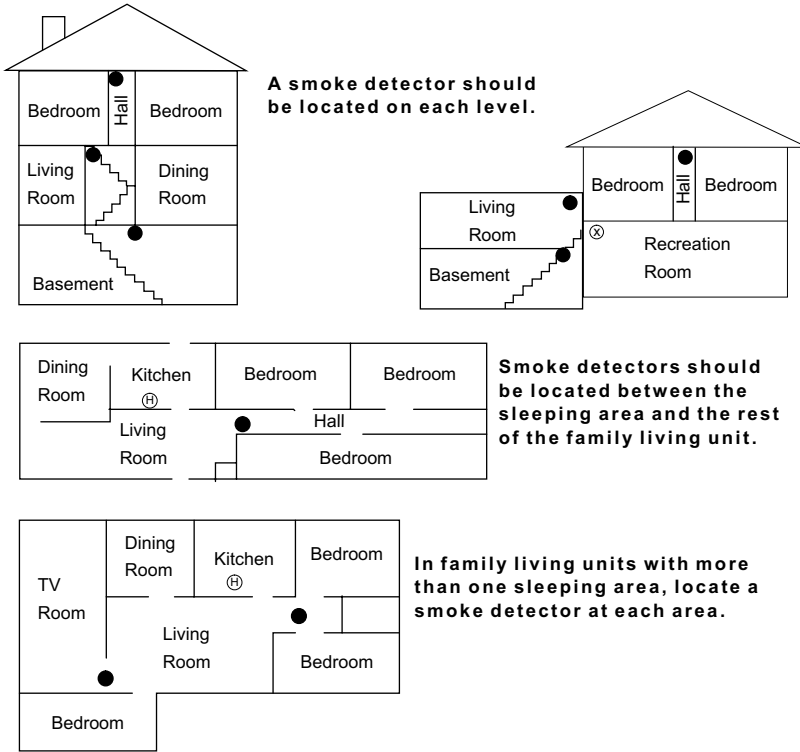

NOTE: Ceiling-mounted smoke detectors should be located in the center of the room or hall, or not less than 4 inches from the wall. When the detector is mounted on the wall, the top of the detector should be 4 to 12 inches from the ceiling.

NOTE: Do not install smoke detectors where normal ambient temperatures are above 100°F or below 40°F. Also, do not locate detectors in front of AC/ Heat registers or other locations where normal air circulation will keep smoke from entering the detector.

NOTE: Additional information on household fire warning is available at nominal cost from: The National Fire Protection Association, Batterymarch Park, Quincy, MA 02269. Request Standard No. NFPA74.

● Required smoke detector

⊕ Heat detector

⊗ Indicates smoke detector is optional if door is not provided between basement and recreation rooms.

8557144a

Figure 8. Floor Plan Example

Floor Plan

Use the space provided (Figure 9) to draw your floor plan and indicate where all system components and sensors are located.

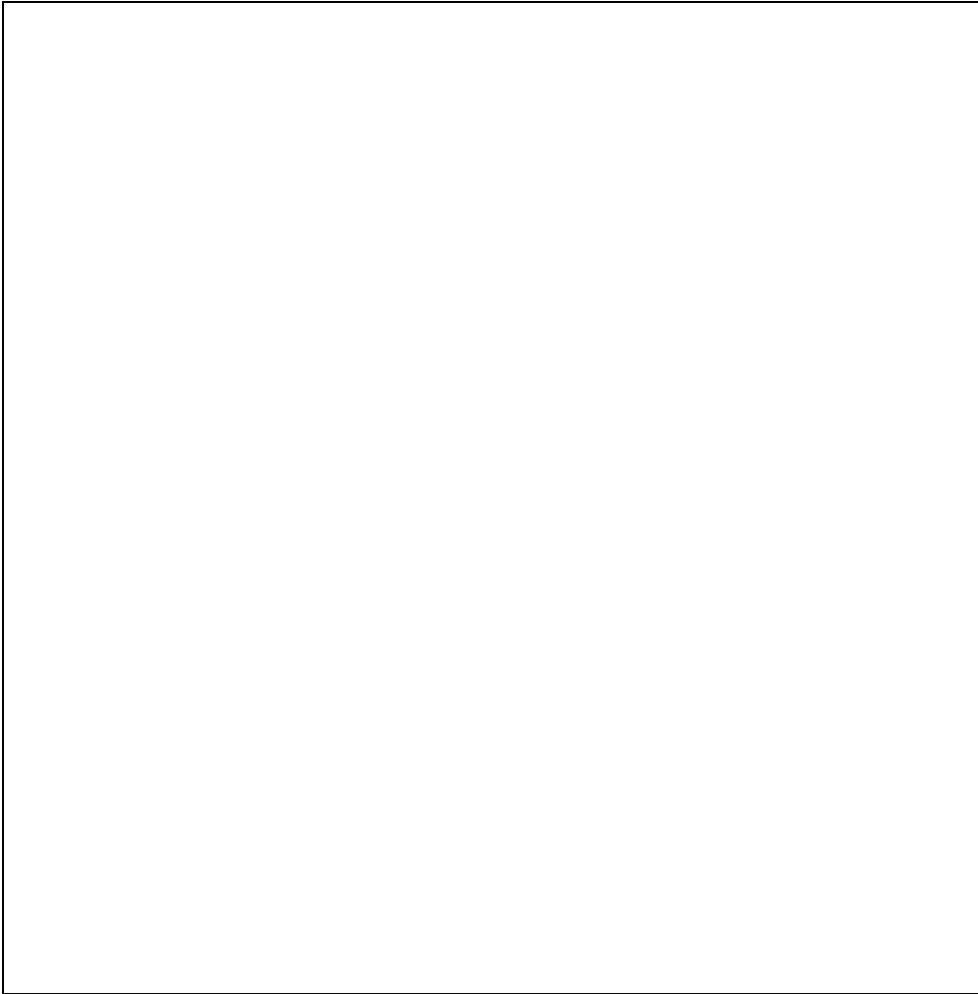

Figure 9. Draw a Floor Plan of the Premises

ALARM SYSTEM NOTICE

Alarm System Limitations

Not even the most advanced alarm system can guarantee protection against burglary, fire, or environmental problems. All alarm systems are subject to possible compromise or failure-to-warn for a variety of reasons.

- If sirens are not placed within hearing range of persons sleeping or in remote parts of the premises, or if they are placed behind doors or other obstacles.
- If intruders gain access through unprotected points of entry or areas where sensors have been bypassed.
- If intruders have the technical means of bypassing, jamming, or disconnecting all or part of the system.
- If power to sensors is disconnected or inadequate.
- If freeze, flood, or any environmental sensors are not located in areas where the appropriate condition can be detected.
- If smoke does not reach a Smoke Sensor. For example, Smoke Sensors cannot detect smoke in chimneys, walls, roofs, or smoke blocked by a closed door. Sensors may not detect smoke on other levels of the building. Sensors may not warn in time when fires are caused by smoking in bed, explosions, improper storage of flammables, overloaded electrical circuits, or other hazardous conditions.
- If telephone lines are out of service. Telephone lines are also vulnerable to compromise by any of several means.

Inadequate maintenance is the most common cause of alarm failure. Therefore, test your system at least once per week to be sure sensors, sirens, and phone communications are all working correctly.

Although having an alarm system may make you eligible for reduced insurance premiums, the system is no substitute for insurance.

WARNING: Security devices cannot compensate you for loss of life or property.

Service

If you have any questions about your system or if you ever need service, please contact your security consultant.

Company Name _____

Phone Number _____

Address _____

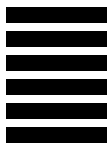

GLOSSARY

access code

A four-digit number that you must enter to control the security system.

alarm

A Panel condition that occurs when a sensor is tripped, if the sensor is active in the current arming level that the system is set to.

arm

To turn on intrusion detection. When arming to level 2, perimeter sensors, such as door/window sensors, are monitored. When arming to level 3, all sensors, including interior sensors such as motion sensors, are monitored. See also *disarm*.

auxiliary/medical alarm

Activated by pressing the **AUXILIARY/MEDICAL** buttons. Turns on interior sirens only and sends an alarm to your monitoring service.

bypass

Have the system ignore selected sensors while the system is armed. For example, to open a monitored door while the system is armed to level 2, bypass the door's sensor. You cannot bypass 24-hour fire sensors.

central monitoring station

See *monitoring service*.

delay

The time you have to enter the premises and disarm the system before an alarm occurs, or the time you have to exit the premises after arming the system before an alarm occurs.

disarm

To turn off intrusion detection (level 1). Only the 24-hour sensors remain on.

fire alarm

Activated by a smoke, heat, or fire pull sensor or the **FIRE** buttons. Turns on interior and exterior sirens and sends an alarm to your monitoring service.

interior sensors

Sensors that monitor the interior of the premises for intruders. Examples of interior sensors: sound sensors, motion sensors, and door/window sensors on interior doors.

intrusion alarm

An alarm that is caused by activating a perimeter or interior sensor. For example, if the system is armed to level 3 and a motion sensor detects motion, an alarm occurs.

intrusion detection

Monitoring provided by perimeter and/or interior sensors. Intrusion detection does not include 24-hour sensors.

Keychain Touchpad

Miniature two- or four-button wireless touchpads that control basic system functions normally performed from the Panel or a wireless touchpad. The built-in light blinks when the Keychain Touchpad has transmitted a signal.

Magic Key

A dime-sized programmable disk. You use the Panel to program the Magic Key for primary or temporary access privileges. Once programmed, you can control the system without entering codes or pressing buttons on the Panel.

monitoring service

The service your system calls to report various system conditions. The monitoring service dispatches the appropriate authorities in an emergency and provides some system programming services.

perimeter sensors

The sensors that monitor exterior doors and windows. Perimeter sensors include door/window and shock sensors.

police alarm

Activated by perimeter or interior sensors or the **POLICE** button. Turns on interior and exterior sirens and calls your monitoring service.

silent duress alarm

Activated by entering the duress code. No sirens are turned on, but the monitoring service is notified of the alarm.

silent duress code

A four-digit code that can be used to disarm the system in an emergency while it sends a silent alarm to the monitoring service.

24-hour sensors

Sensors that monitor the interior of the premises for threats that are not caused by intruders. Examples of 24-hour sensors: heat sensors, freeze sensors, and smoke sensors.



INDEX

A

- AC power
 - see power
- access code
 - defined – 15
 - if you forget – 15, 45
 - primary – 15
 - secondary – 16
 - temporary – 16
 - troubleshooting – 45
- accidental alarm
 - see alarm, turning off
- alarm
 - activating – 24
 - auxiliary/medical
 - see auxiliary/medical alarm
 - checking for – 35
 - clearing memory – 36
 - fire
 - see fire alarm
 - light response – 30
 - police
 - see police alarm
 - preventing – 17, 27, 28
 - sounds – 12
 - system limitations – 53
 - turning off – 20, 24, 45
- arm
 - defined – 20
 - security levels – 18
 - sensors active
 - in level 1 (24-hr) – 18
 - in level 2 – 18
 - in level 3 – 18
 - troubleshooting – 45
 - unable to – 45
 - using COMMAND button – 21, 33
 - using Handheld Touchpad – 21
 - using Keychain Touchpad – 21, 33
 - using Magic Key – 22
 - using Panel – 21, 33

- with No Delay – 27
 - with sensor bypass – 28
- arming level beeps – 13
- AUXILIARY button – 24
- auxiliary/medical alarm
 - activating
 - using COMMAND button – 24
 - using Handheld Touchpad – 23
 - using Panel – 23, 24
 - description of – 22, 23
 - sound – 12
- AWAY
 - button – 20
 - indicator light – 11

B

- battery
 - failure – 39, 45
 - installing/replacing
 - backup batteries – 41
 - in other sensors – 44
 - in smoke sensors – 44, 47
 - troubleshooting – 45
 - types
 - lithium – 44
 - type indicator – 43
 - using the right type – 42
 - 9-volt – 44
- beeps – 13, 47
- bypass
 - direct
 - defined – 28
 - performing – 29
 - indirect
 - defined – 28
 - performing – 28
 - removing – 28
 - removing – 28
 - all – 29
 - single – 29

troubleshooting – 45
BYPASS button – 28

C

changing
 primary access code – 15
 see also battery, installing/replacing
 temporary access code – 16
checking
 for alarms
 see alarm, checking for
 system status – 35, 39
chime – 13, 29
CHIME button – 29
code
 see access code
 see also silent duress alarm, activating
COMMAND
 button – 21, 24
COMMAND button
 arming to level 2 – 33
 arming to level 3 – 33
 turning lights on/off – 30
Control Panel, see Panel

D

delay – 17
direct bypass
 see bypass, direct
disarm
 defined – 18
 sensors active – 18
 to level 1 – 18
 troubleshooting – 45
 using Handheld Touchpad – 18
 using Keychain Touchpad – 19
 using Magic Key – 19
 using Panel – 18
duress alarm
 see silent duress alarm
duress code
 see silent duress alarm

E

emergency
 alarm
 see alarm
 planning for – 49, 50
entering/exiting the premises – 17
entry delay beeps – 13
escape plan
 see floor plan
extended delay – 17

F

failure
 battery – 39
 power – 39
false alarm
 turning off – 45
fire alarm
 activating
 using Panel – 23, 24
 description of – 22, 23
 placement – 50, 51, 53
 sound – 12
FIRE button
 description of – 24
floor plan – 50, 51

H

Handheld Touchpad – 24

I

indicator lights – 11, 46
indirect bypass
 see bypass, indirect
installing batteries
 see battery, installing/replacing

K

key
 see Magic Key

Keychain Touchpad – 33
 activating an alarm using – 24, 34
 arming
 with no alarm delay time – 33
 with No Delay – 27
 arming using – 21
 bypassing sensors indirectly using – 28, 34
 disarming using – 19, 34
 list of functions – 32
 turning lights on/off – 30, 35

L

lamp modules
 see X-10 Lamp Module

level 1
 defined – 18
 disarming to – 18, 19
 sensors active in – 18

level 2
 arming to – 21, 33
 defined – 20
 sensors active in – 18

level 3
 arming to – 21, 33
 defined – 20
 sensors active in – 18

lights
 see also indicator lights
 table of – 11
 troubleshooting – 46
 turning on/off
 using Handheld Touchpad – 30
 using Keychain Touchpad – 30, 35
 using Panel – 30

M

Magic Key
 arming to level 2 – 22
 arming to level 3 – 22
 disarming using – 19
 programming
 for primary access – 31
 for temporary access – 32
 troubleshooting – 46

voice messages
 Failure, good-bye – 32
 Invalid, try again – 32
 Memory OK – 32
 when to reprogram – 32

maintaining system – 39
messages
 see voice messages
monitoring service – 8, 23, 25

N

No Delay
 button – 27
 defined – 27
 indicator light – 11

O

OFF button – 18

P

Panel
 alarm sounds – 12
 beeps – 13
 functions – 8
 indicator lights – 11
 operation – 15, 27
 testing status – 39
 troubleshooting – 46
 voice messages
 description of – 14
 see also voice messages
 volume control – 37

phone
 test – 39
 troubleshooting – 47, 53

police alarm
 activating
 using Handheld Touchpad – 23, 24
 using Keychain Touchpad – 23, 24, 34
 using Panel – 23, 24
 description of – 22, 23
 sound – 12

- POLICE button
 - description of – 24
- power
 - failure – 39
 - see also battery
 - troubleshooting – 46
- POWER indicator lights – 11
- premises
 - entering/exiting – 17
 - floor plan – 51
- primary access
 - code
 - changing – 15
 - if you forget – 15
 - defined – 15
 - using Magic Key – 31
- problems
 - see troubleshooting
- protest beeps – 13

R

- READY indicator light – 11
- replacing batteries
 - see battery, installing/replacing

S

- secondary access
 - code
 - adding – 16
 - changing – 16
 - defined – 16
- sensor
 - alarm memory – 36
 - batteries – 44
 - bypass – 28
 - bypassing – 35
 - cover off – 35
 - how to activate – 41
 - low battery – 35
 - number
 - AUXILIARY button – 24
 - FIRE button – 24
 - POLICE button – 24
 - open – 35

- status – 35
- test – 40
- troubleshooting – 46, 47
- wireless – 8
- 24-hour – 18, 20, 24
- silent duress alarm
 - activating
 - using Handheld Touchpad – 25
 - using Panel – 23
 - defined – 25
 - description of – 22
 - turning off – 25
- siren
 - description of – 9
 - see also alarm
 - sounds – 12
 - Wireless Interior Siren
 - troubleshooting – 47
- smoke sensor – 44
- sounds
 - alarm – 12
 - auxiliary/medical alarm – 12
 - fire alarm – 12
 - police alarm – 12
 - siren – 12
- speaker volume – 37
 - see also voice messages
- standard delay – 17
- status
 - alarm memory – 36
 - beeps – 13
 - checking – 35
 - checking after disarming – 18
 - checking system – 39
 - of alarm memory – 35
 - of backup batteries – 35
 - of sensor batteries – 35
 - of system – 35, 39
 - voice messages – 36
- STATUS button – 39
- STAY
 - button – 20
 - indicator light – 11
- supervised – 5
- system
 - beeps – 13
 - communication – 11

- components – 5
- maintaining – 39
- status beeps – 13
- testing status – 39

- system battery
 - see battery

T

- temporary access
 - code
 - defined – 16
 - disabling – 16
 - using with Magic Key – 32

- test
 - phone – 39
 - sensor – 40
 - system status – 39

- touchpad
 - handheld
 - see handheld Touchpad

- touchpad, Keychain
 - see Keychain Touchpad

TROUBLE

- indicator light – 11

- trouble beeps – 13
 - see also beeps

- troubleshooting
 - access code – 45
 - arming – 45
 - battery – 45
 - bypass – 45
 - disarming – 45
 - indicator lights – 11
 - Magic Key – 46
 - phone – 47
 - power – 11, 46
 - sensors – 46, 47
 - system – 45

- turning off sensors
 - see bypass

V

- voice messages
 - alarm memory – 36

- defined – 14
- for Magic Key – 32
- for system status – 36, 39
- volume control – 37

- volume control – 37

W

- wireless
 - defined – 5
 - sensors, defined – 8
 - touchpad – 9

- Wireless Interior Siren
 - see siren, Wireless Interior Siren

X

- X-10 Lamp Module
 - defined – 30
 - panel control – 30
 - see also lights
 - user control – 30

NUMERICS

- 24-hour sensors
 - see sensor, 24-hour